

Plate Heat Exchangers

Series FP, FPDW



With partnership into the future

FUNKE is a leader in the development and production of quality heat exchangers with a heat transfer area of up to 2 400 m². The range of products comprises shell-and-tube heat exchangers, bolted and brazed plate heat exchangers as well as oil/air cooling units and electrical oil pre-heaters. Thus, as one of the few producers worldwide, FUNKE offers solutions with optimum thermodynamic designs for different industries and virtually all applications.

FUNKE focuses on customer orientation, highest quality standards, flexibility and advisory skills – important benefits a company of just the right size is able to offer.



Your specialist for heat exchangers

Satisfied and regular customers are evidence for the reliability and quality FUNKE guarantees.

FUNKE's broad product range comprises

- Plate Heat Exchangers (bolted and brazed)
- Shell-and-Tube Heat Exchangers
- Oil/Air Cooling Units
- Electrical Oil Pre-heaters

FUNKE offers a wide range of plate heat exchangers (PHE) to meet almost any requirement in machine and plant engineering with regard to heat transfer.

Benefits of FUNKE plate heat exchangers (PHE)

- low investment, operation and maintenance costs
- highly efficient heat transfer (K-values on average 3-5 times higher compared to bare-tube heat exchangers)
- for economic solutions asymmetrical flow gaps are available
- exploitation of even smallest temperature differences ≤ 1 K
- up to 75% less space required
- self-cleaning effect due to highly turbulent flow behaviour
- future additional capacity is possible by fitting extra heat transfer plates
- high safety measures avoid media mixing
- easy to open/clean
- low operating weight/low liquid content

Technical key data (depending on design)		
Capacity	1 KW	- 30 MW
Volume flow	5 m ³ /h	- 4500 m ³ /h
Surface/plate	0,04 m ²	- 3,0 m ²
Nominal connection diameter	DN 25	- DN 500
Operating temperature	-20°C	- +195°C
Working pressure		max. 25 bar

Series	
FP	gasketed/ bolted PHE (standard design)
FPDW	safety PHE (double-wall plate design)

Design and function of FUNKE PHE

The heart of a PHE is a pack of embossed plates with apertures. The plates are assembled in a 180° angle to each other, resulting in flow gaps on each side. Each plate is provided with a gasket, which securely seals the flow gaps from the atmosphere and separates the two media used in the heat exchange.

The gasketed plate pack is mounted in a rack and is compressed with tightening bolts between the fixed plate and the movable plate. To guarantee maximum heat transfer, warm and cold media are normally led through the PHE in one-pass or multi-pass counterflow. Connections are on the fixed plate, but can also be on the movable plate for multi-pass flow (see principle sketches below).

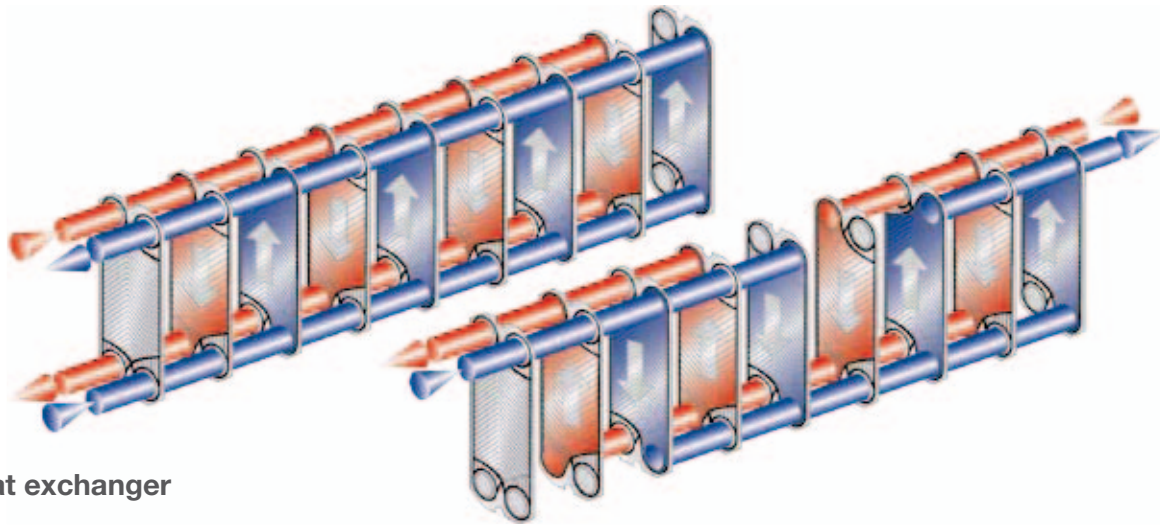

Design of a plate heat exchanger

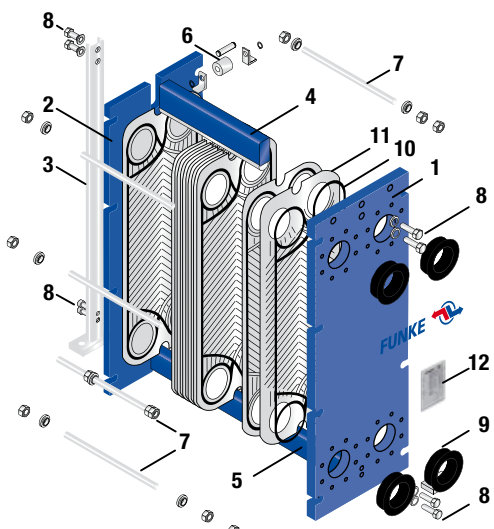

1. Fixed plate
2. Movable plate
3. Support column
4. Carrying bar
5. Lower plate guiding bar
6. Carrier roller
7. Tightening bolt and nuts
8. Fixing bolts
9. Rubber/metal liners
10. Gaskets
11. Heat transfer plates
12. Name plate

Connection positions



single-pass

two-pass

three-pass

Always the right plate for your requirements

"Off-Set"- embossing for highest efficiency

All plate heat exchangers look very similar at first glance. But the difference and the secret of efficient heat transfer cannot be seen from the outside – it is the wave pattern. Its performance depends on many factors, including size and number of plates. Altogether, these factors determine the size of the plate heat exchangers and the operating costs. A crucial factor e.g. is that plates with different plate corrugation angles (in relation to the flow direction) can be combined. Obtuse corrugation angles result in longer thermal paths (H) and higher heat transfer rates but also lead to higher pressure drops. Acute corrugation (L) angles are chosen if the pressure drop must be kept low.

FUNKE plate heat exchangers offer more advantages by combining different plate corrugations- with the unique "Off-Set" profile even asymmetrical flow gaps can be formed. Therefore, the cross-sectional areas of the warm and the cold side of the PHE can approximately be one third larger or smaller (see pictures and graphics below).

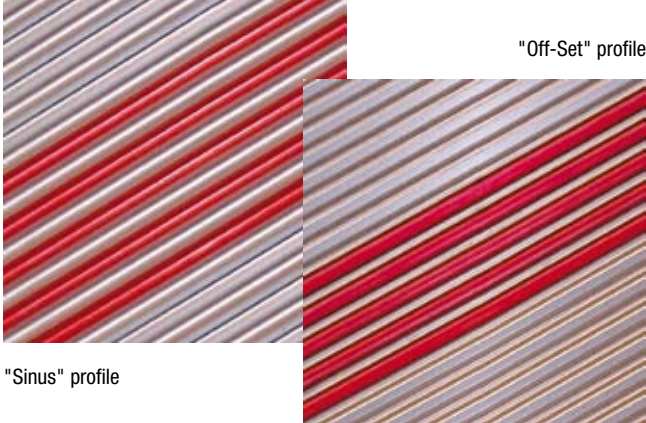
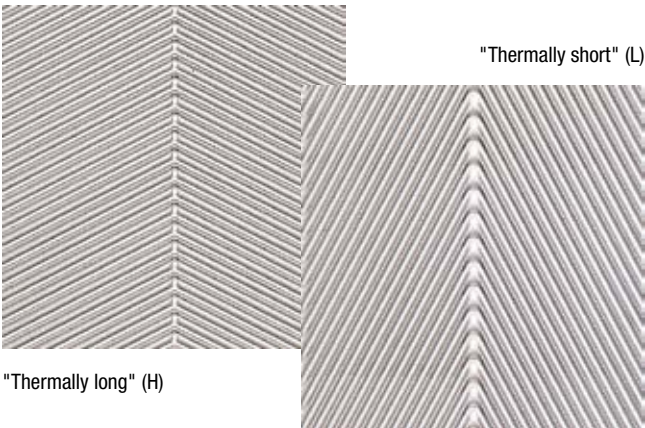

With the sophisticated "Off-Set" profile our customers benefit from an additional tool for providing cost-effective PHE solutions. An oil cooler, for example, is significantly smaller and cheaper if the volume flow on the cooling water side can be much larger. Therefore, up to 17 per cent less exchange surface is required compared to conventional symmetrical plates. The configuration of the plate pack is always calculated using state-of-the-art design software, whether symmetrical or asymmetrical. So, FUNKE always aims to find the most efficient and cost effective solution for the customer.

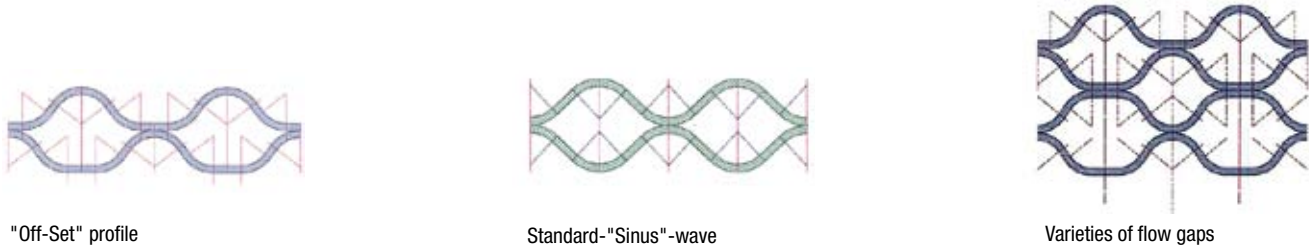

Double-wall plates

These plates provide maximum protection against the mixing of media used in the heat exchange process. Two simultaneously embossed plates are laser-welded at the port holes. If there is a leak, fluids can escape at the edges of the plate pair.

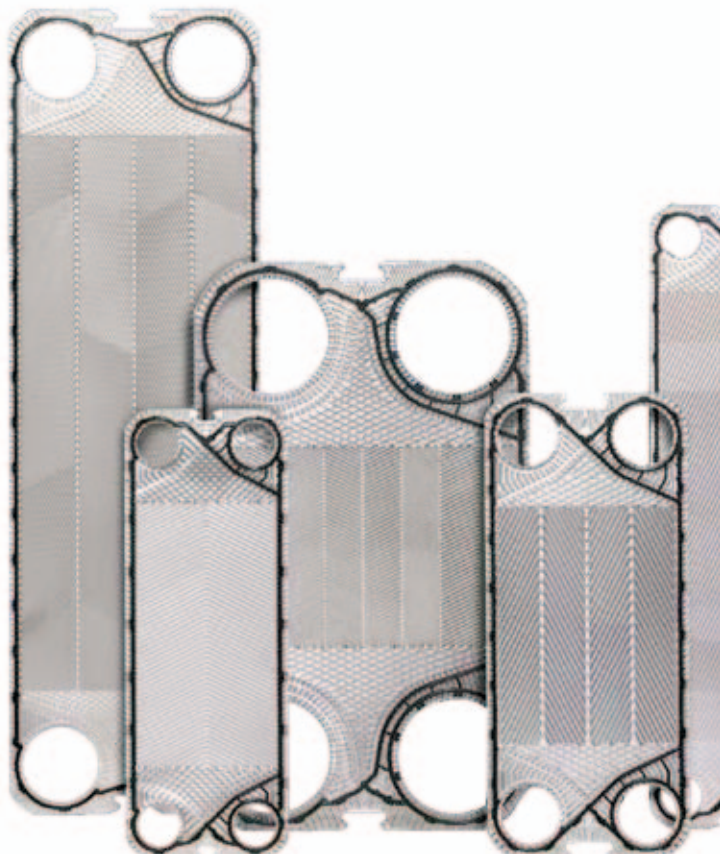
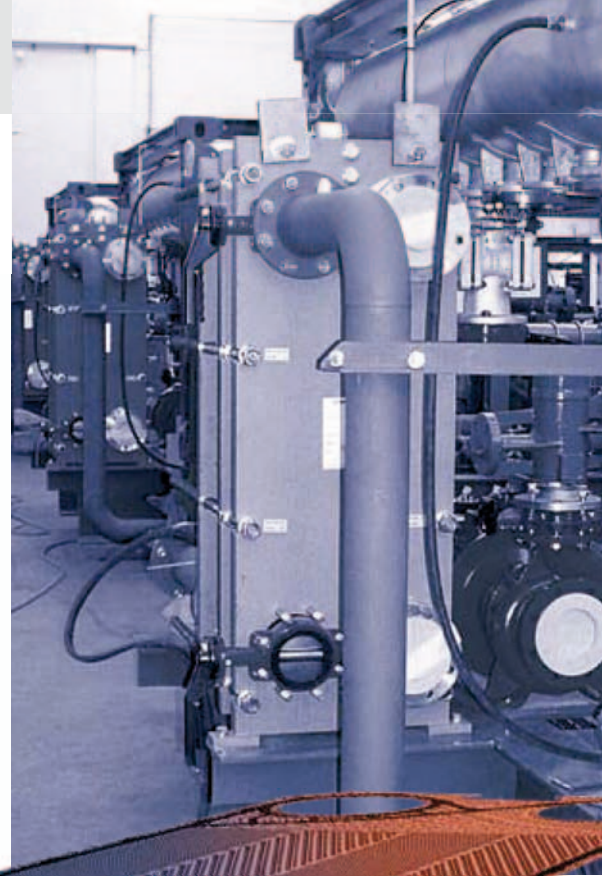
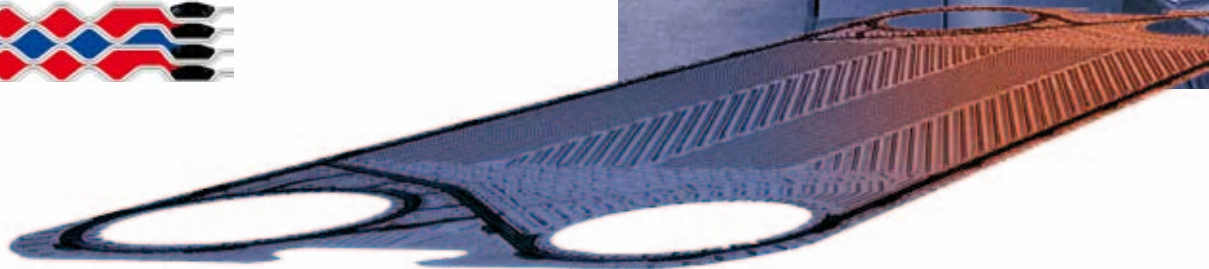
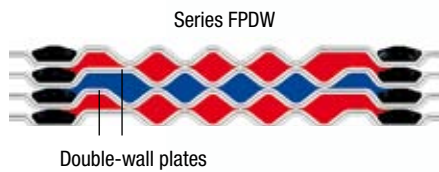

Short overview of plate and gasket:

- very high heat transfer rates due to thermodynamically optimized design
- corrugation fields with "Off-Set" embossing allow for symmetrical and asymmetrical flow gaps (1)
- specially embossed entry fields for an optimum distribution of media (2)
- gaskets fastened by "Clip-system" for easy maintenance
- gaskets have a special ribbed surface, enabling more exact centring and stabilization of the entire plate pack (3)
- double gasket with leakage groove between two media, preventing mixing of the media (4)
- special plate profile at the edges, reinforcing the plate pack and ensuring high pressure resistance of the gasket during operation (5)

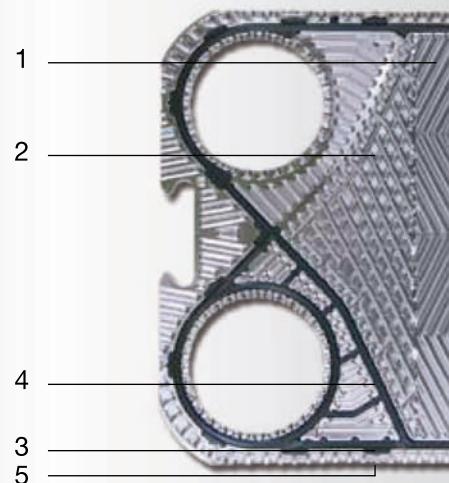

Technical data

Plate material

As standard, FUNKE heat transfer plates are produced in 1.4404 / AISI 316L. Due to the high content in molybdenum, this material is generally more corrosion-resistant and more resistant to chloride damage than 1.4301 / AISI 304.

Optionally, the following additional materials may be used:

- 1.4301 / AISI 304 (cost-effective for use with uncritical media)
- 1.4539 / AISI 904L (with high nickel content to avoid stress corrosion cracking; good price/performance ratio when media with a low acid and chloride content are applied)
- 1.4547 / 254 SMO (higher chloride and acid-resistance than 1.4404 / AISI 316L)
- Alloy C276 (highly resistant against acids and chlorides; e.g. for concentrated sulphuric acid)
- Titanium ASTM B 265 Grade 1
- Titanium-Palladium ASTM B265 Grade 11 (highest material quality; appropriate e.g. for chlorides at higher temperatures)

Accessories

Optionally, we equip your plate heat exchanger with the following accessories:

- insulations (e.g. mineral insulation material clad with galvanised sheet; other claddings optional)
- inline-filters
- special painting (e.g. sea air resistant paint)
- shroud / drip tray
- earthing lugs
- CIP cleaning system

Special equipment

- frames made of stainless steel or with stainless steel cladding
- PHE as double cooler with switch-over valve and thermostat

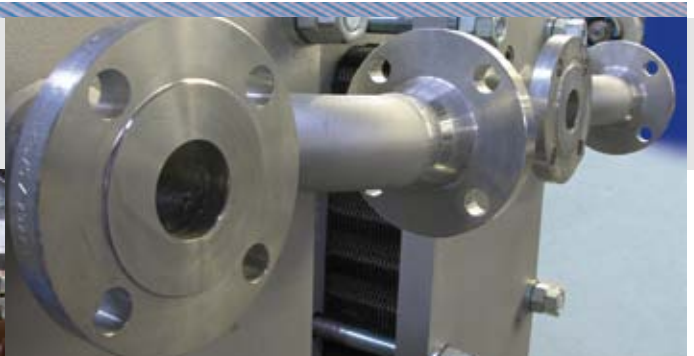

Connections

FUNKE plate heat exchangers can be supplied with all common connections (threaded or flange connection, connection with loose flange, moulded rubber part or metal lining; others on request) for any application (industry, building services, chemicals, food). Of course, all common materials as well as welded designs are available.

Gasketing

Depending on the design and the type, adhesive or non-adhesive (Clip-system) gaskets may be used. As gasket materials, well-known, proven and tested materials are used, such as:

- NBR (nitrile-rubber): universally applicable for aqueous and oily fluids e.g. water / oil-applications
- EPDM (ethylene-propylene-rubber): wide range of applications for many chemical compounds which do not contain mineral oil and grease; also for water and steam applications
- Fluororubber (Viton): extremely resistant to chemicals and organic solvents, also to sulphuric acid and vegetable oils at high temperatures
- other materials on request

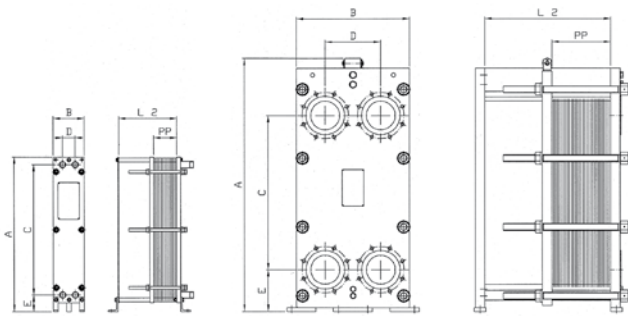

Dimensions

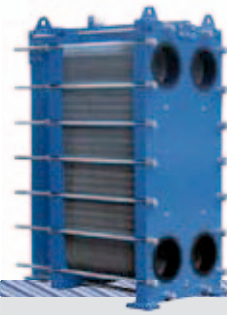

frame / pressure rating	max. pressure range bar	max. number of plates	surface / plate m ²	A	B	C	D	E	L2	PP	connections	max. surface m ²
				mm	mm	mm	mm	mm	mm	mm		
FP 04	16	125	0,04	460	160	336	65	85	150-600	pcs. x 2,4	1"	5
FP 08	16	150	0,08	800	160	675	65	85	150-600	pcs. x 2,4	1"	12
FP 14	16	200	0,14	837	310	590	135	132	250-1000	pcs. x 2,4	2"	28
FP 20	16	200	0,20	1066	310	819	135	132	250-1000	pcs. x 2,4	2"	40
FP 05	25	150	0,04	532	200	381	70	45	250-1000	pcs. x 2,7	1"	6
FP 09	25	150	0,08	827	200	676	70	45	250-1000	pcs. x 2,7	1"	12
FPDW 05	16	150	0,04	532	200	381	70	45	250-1000	pcs. x 2,9	1"	6
FP 10	25	200	0,10	733	310	494	126	128	250-1000	pcs. x 2,9	2"	20
FP 16	25	200	0,16	933	310	694	126	128	250-1000	pcs. x 2,9	2"	30
FP 22	25	200	0,21	1182	310	894	126	128	250-1000	pcs. x 2,9	2"	45
FPDW 16	25	200	0,16	933	310	694	126	128	250-1000	pcs. x 3,1	2"	30
FP 19	16	500	0,19	1080	440	650	202	200	500-2500	pcs. x 3,1	DN 80	100
FPDW 19	16	500	0,19	1080	440	650	202	200	500-2500	pcs. x 3,1	DN 80	100
FP 205	25	500	0,21	1160	480	719	225	204	500-2500	pcs. x 3,1	DN 100	105
FP 31	25	500	0,30	1332	480	894	225	204	500-3000	pcs. x 3,1	DN 100	150
FP 40	25	500	0,40	1579	480	1141	225	204	500-3000	pcs. x 3,1	DN 100	200
FP 50	25	500	0,50	1826	480	1388	225	204	500-3000	pcs. x 3,1	DN 100	250
FP 71	25	500	0,70	2320	480	1882	225	204	500-3000	pcs. x 3,1	DN 100	350
FPDW 205	16	500	0,21	1160	480	719	225	204	500-3000	pcs. x 3,3	DN 100	105
FPDW 31	16	500	0,30	1332	480	894	225	204	500-3000	pcs. x 3,3	DN 100	200
FPDW 50	16	500	0,50	1826	480	1388	225	204	500-3000	pcs. x 3,3	DN 100	250
FP 41	25	700	0,40	1470	620	941	290	225	500-4000	pcs. x 3,5	DN 150	280
FP 60	25	700	0,60	1835	620	1306	290	225	500-4000	pcs. x 3,5	DN 150	420
FP 80	25	700	0,80	2200	620	1671	290	225	500-4000	pcs. x 3,5	DN 150	560
FPDW 80	16	700	0,80	2200	620	1671	290	225	500-4000	pcs. x 3,7	DN 150	560
FP 42	25	750	0,40	1470	620	941	290	225	500-4000	pcs. x 3,1	DN 150	315
FP 62	25	750	0,60	1835	620	1306	290	225	500-4000	pcs. x 3,1	DN 150	450
FP 82	25	750	0,80	2200	620	1671	290	225	500-4000	pcs. x 3,1	DN 150	600
FP 112	25	750	1,15	2687	620	2157	290	225	500-4000	pcs. x 3,1	DN 150	840
FP 405	25	700	0,41	1380	760	770	395	285	500-4000	pcs. x 3,1	DN 200	300
FP 70	25	700	0,70	1740	760	1130	395	285	500-4000	pcs. x 3,1	DN 200	355
FP 100	25	700	1,00	2100	760	1490	395	285	500-4000	pcs. x 3,1	DN 200	700
FP 130	25	700	1,30	2460	760	1850	395	285	500-4000	pcs. x 3,1	DN 200	910
FPDW 100	16	700	1,00	2100	760	1490	395	285	500-4000	pcs. x 3,3	DN 200	700
FP 81	25	800	0,80	1930	980	1100	480	365	1780-5280	pcs. x 3,8	DN 300	640
FP 120	25	800	1,20	2320	980	1490	480	365	1780-5280	pcs. x 3,8	DN 300	960
FP 160	25	800	1,60	2710	980	1879	480	365	1780-5280	pcs. x 3,8	DN 300	1280
FP 190	25	800	1,90	3100	980	2267	480	365	1780-5280	pcs. x 3,8	DN 300	1520
FP 150	25	800	1,50	2500	1370	1466	672	480	1980-5980	pcs. x 4,1	DN 500	1600
FP 200	25	800	2,00	2855	1370	1822	672	480	1980-5980	pcs. x 4,1	DN 500	1600
FP 250	25	800	2,50	3211	1370	2178	672	480	1980-5980	pcs. x 4,1	DN 500	2000
FP 300	25	800	3,00	3567	1370	2534	672	480	1980-5980	pcs. x 4,1	DN 500	2400

FP gasketed / bolted PHE (standard design) · FPDW safety PHE (double-wall plate design) · More types and sizes on request · Technical changes reserved
 pcs. = number of plates



Hydraulic oil cooling in power plant.



Cooling of lubricating oil for extruding presses.

FUNKE customers value reliability



Condensation of bioethanol.

Cooling of hydraulic oil for high pressure air compressors in oil exploration.



Cooling of laser welding plants in automotive production.

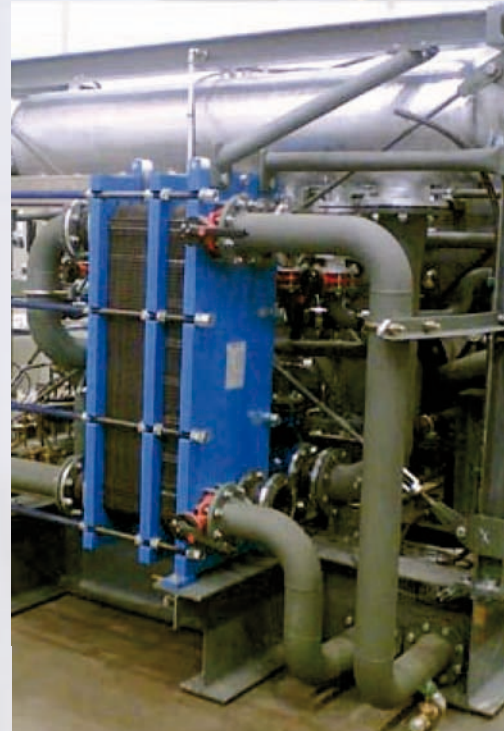
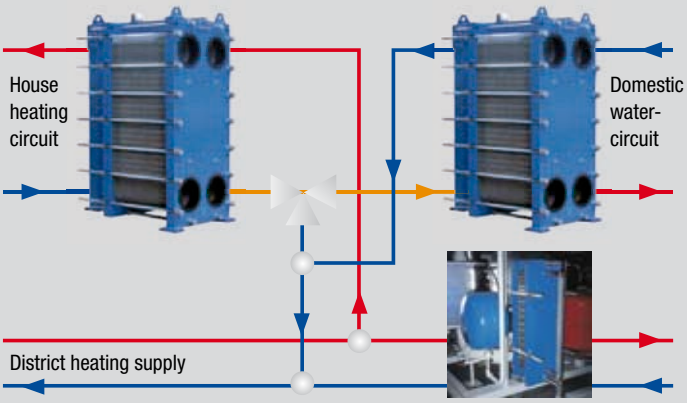

Plate heat exchangers as double oil cooler with transflow valves and temperature control.



Industrial applications – PHEs in heating, ventilation, air condition (Example: district heating system)



Industrial applications – PHEs in refrigeration engineering

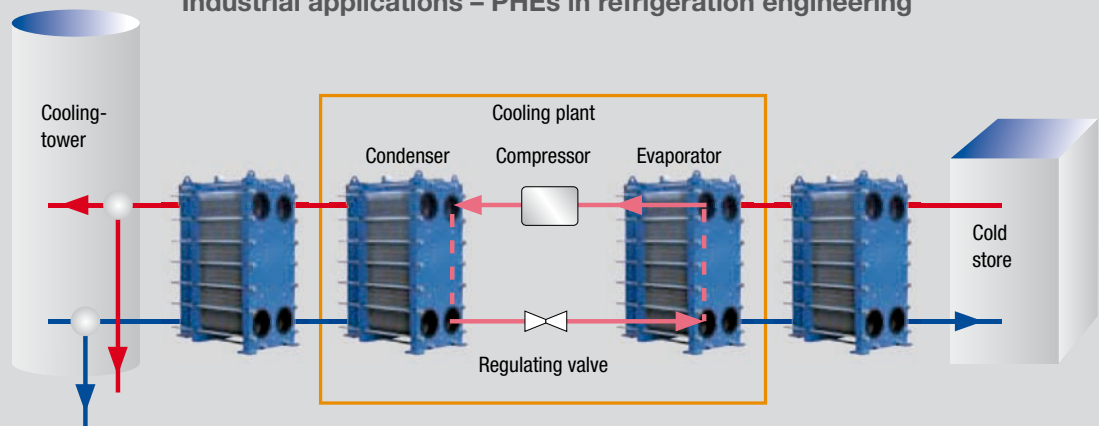

Quality production at FUNKE



Lifetime partnership – our service for your PHE

The design and the high quality standards of FUNKE plate heat exchangers aim to keep maintenance work to a minimum, provided that the conditions of use the PHE has been designed for are adhered to. However, during service life, the gaskets of a PHE are subject to a normal fatigue process. Depending on the conditions of use, the plate pack can be tightened several times until the lower limit 'PP-min.' is reached, at this time gaskets need replacement. Normally, maintenance and servicing can be carried out by adequately trained personnel of the operator. If you need help, contact our local service technicians or service partners who will provide the services as follows:

Our service proposal for your PHE

- cleaning service: CIP (Cleaning in Place) or mechanical cleaning on site or chemical cleaning (immersion bath) at the factory
- on request, complete CIP systems (incl. the required cleaning chemicals) can be provided by FUNKE
- replacing gaskets: this always includes cleaning of plates; crack test is optional
- spare parts service: supply of original parts throughout the world
- overhaul of complete unit
- future supplementary performance optimization: extension of plate pack/change in plate configuration

Required data for the best PHE design

The desired performance of the PHE can be achieved by very different configurations. With precise knowledge of all process conditions we can offer our customers the most efficient and cost-effective PHE.

Required data can be found on our quotation questionnaire at our website. If you require assistance, please do not hesitate to contact us. We will be pleased to assist you.

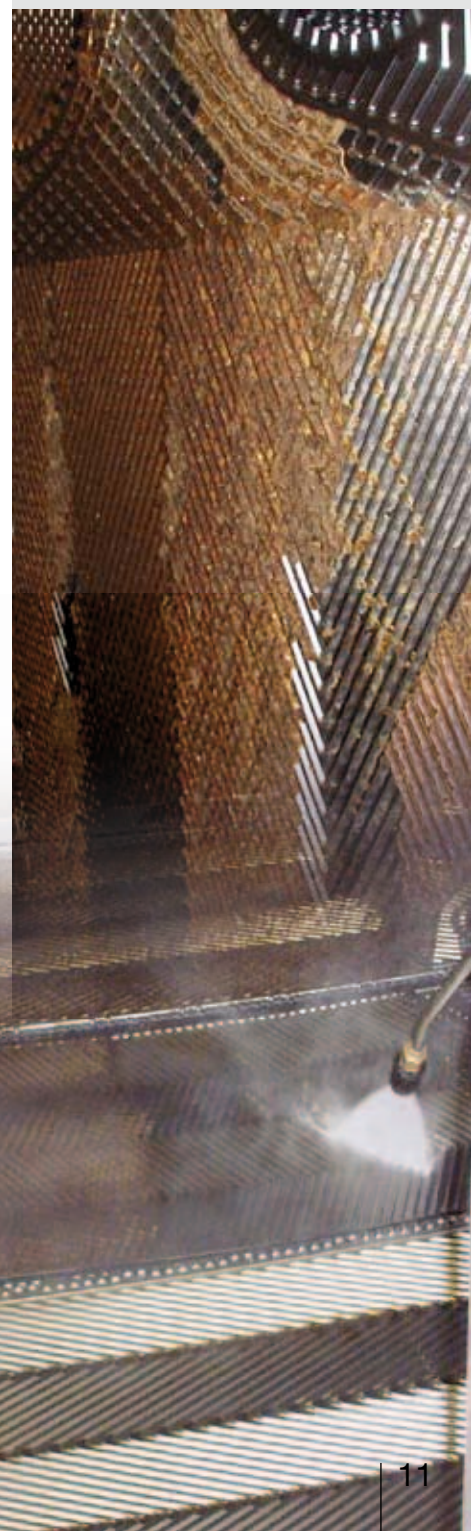
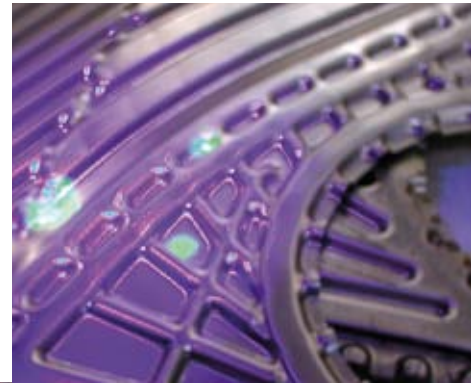



Quality means safety. Each unit built by FUNKE is design and pressure tested. Additional approvals are also available in accordance with quality authorities such as:

- American Bureau of Shipping (ABS)
- Bureau Veritas (BV)
- Det Norske Veritas (DNV)
- Germanischer Lloyd (GL)
- Lloyds Register of Shipping (LRS)
- Technischer Überwachungsverein (TÜV)

as well as customers' test and inspection regulations.

FUNKE has been certified according to DIN EN ISO 9001:2008, DIN EN ISO 14001:2004 and is an approved manufacturer according to:

- EU Pressure Equipment Directive 97/23/EC (PED), Module H/H1
- HP0 in connection with DIN EN 729-2
- ASME U-Stamp incl. ASME R-Stamp
- Custom Union (TRTS 032/2013)
- China Certificate



Funke Wärmeaustauscher Apparatebau GmbH
Zur Dessel 1
31028 Gronau/Leine · Germany

T +49 (0) 51 82 / 582-0
F +49 (0) 51 82 / 582-48

info@funke.de
www.funke.de

